

MM3Z2V2B~MM3Z39B

Silicon Planar Zener Diodes

Features

- Total power dissipation : max. 300 mW
- Small plastic package suitable for surface mounted design
- High reliability

Description

Silicon planar Zener diode in a small plastic SMD SOD-323 package

PINNING

PIN	DESCRIPTION
1	Cathode
2	Anode

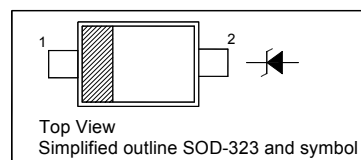

Absolute Maximum Ratings ($T_a = 25\text{ }^\circ\text{C}$)

Parameter	Symbol	Value	Unit
Power Dissipation	P_{tot}	300	mW
Junction Temperature	T_j	150	$^\circ\text{C}$
Storage Temperature Range	T_{stg}	- 55 to + 150	$^\circ\text{C}$

Characteristics at $T_a = 25\text{ }^\circ\text{C}$

Parameter	Symbol	Max.	Unit
Thermal Resistance Junction to Ambient Air	R_{thA}	417	$^\circ\text{C/W}$
Forward Voltage at $I_F = 10\text{ mA}$	V_F	0.9	V

MM3Z2V2B~MM3Z39B

Characteristics at $T_a = 25\text{ }^\circ\text{C}$

Type	Marking Code	Zener Voltage Range ¹⁾			Dynamic Impedance		Reverse Leakage Current	
		V_{znom} V	I_{zT} mA	for V_{zT} V	Z_{zT} (Max.) Ω	at I_{zT} mA	I_R (Max.) μA	at V_R V
MM3Z2V2B	MF	2.2	5	2.1...2.4	100	5	120	0.7
MM3Z2V4B	7C	2.4	5	2.3...2.65	100	5	120	1
MM3Z2V7B	7D	2.7	5	2.65...2.95	110	5	120	1
MM3Z3V0B	7E	3.0	5	2.95...3.25	120	5	50	1
MM3Z3V3B	7F	3.3	5	3.25...3.55	120	5	20	1
MM3Z3V6B	7H	3.6	5	3.6...3.845	100	5	10	1
MM3Z3V9B	7J	3.9	5	3.89...4.16	100	5	5	1
MM3Z4V3B	7K	4.3	5	4.17...4.43	100	5	5	1
MM3Z4V7B	7M	4.7	5	4.55...4.75	100	5	2	1
MM3Z5V1B	7N	5.1	5	4.98...5.2	80	5	2	1.5
MM3Z5V6B	7P	5.6	5	5.49...5.73	60	5	1	2.5
MM3Z6V2B	7R	6.2	5	6.06...6.33	60	5	1	3
MM3Z6V8B	7X	6.8	5	6.65...6.93	40	5	0.5	3.5
MM3Z7V5B	7Y	7.5	5	7.28...7.6	30	5	0.5	4
MM3Z8V2B	7Z	8.2	5	8.02...8.36	30	5	0.5	5
MM3Z9V1B	8A	9.1	5	8.85...9.23	30	5	0.5	6
MM3Z10B	8B	10	5	9.77...10.21	30	5	0.1	7
MM3Z11B	8C	11	5	10.76...11.22	30	5	0.1	8
MM3Z12B	8D	12	5	11.74...12.24	30	5	0.1	9
MM3Z13B	8E	13	5	12.91...13.49	37	5	0.1	10
MM3Z15B	8F	15	5	14.34...14.98	42	5	0.1	11
MM3Z16B	8H	16	5	15.85...16.51	50	5	0.1	12
MM3Z18B	8J	18	5	17.56...18.35	65	5	0.1	13
MM3Z20B	8K	20	5	19.52...20.39	85	5	0.1	15
MM3Z22B	8M	22	5	21.54...22.47	100	5	0.1	17
MM3Z24B	8N	24	5	23.72...24.78	120	5	0.1	19
MM3Z27B	8P	27	5	26.19...27.53	150	5	0.1	21
MM3Z30B	8R	30	5	29.19...30.69	200	5	0.1	23
MM3Z33B	8X	33	5	32.15...33.79	250	5	0.1	25
MM3Z36B	8Y	36	5	35.07...36.87	300	5	0.1	27
MM3Z39B	8Z	39	5	37...41	100	5	2	30

¹⁾ V_z is tested with pulses (20 ms).

MM3Z2V2B~MM3Z39B

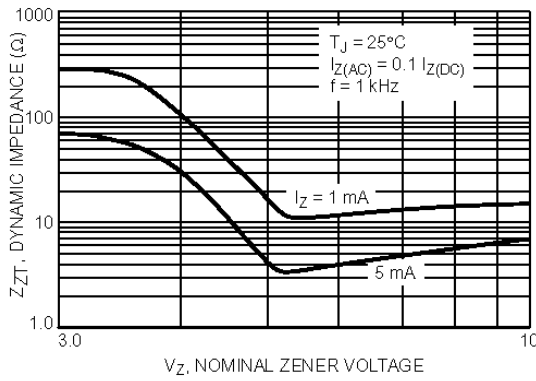

Effect of Zener Voltage on Zener Impedance

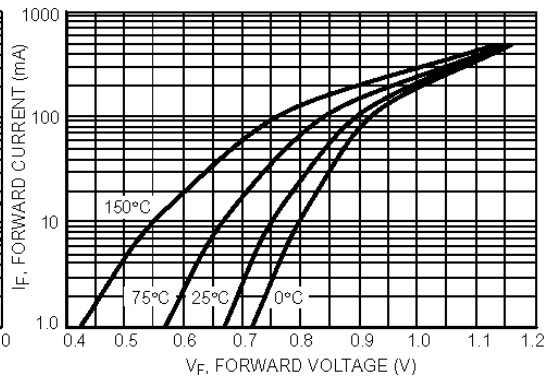

Typical Forward Voltage

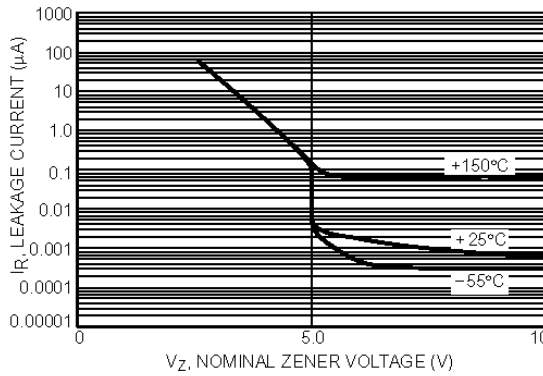

Typical Leakage Current

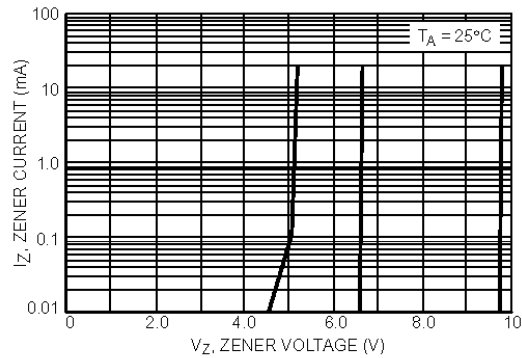

Zener Voltage versus Zener Current (V_Z Up to 9 V)

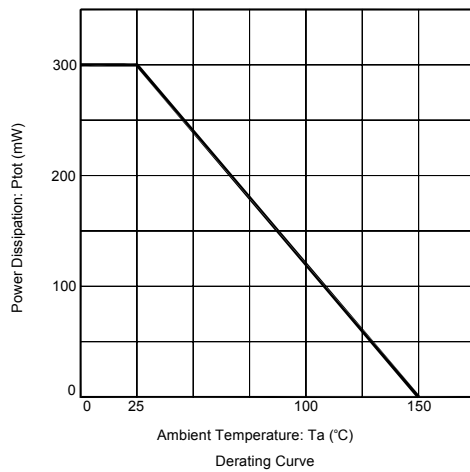

MM3Z2V2B~MM3Z39B

PACKAGE OUTLINE

Plastic surface mounted package; 2 leads

SOD-323

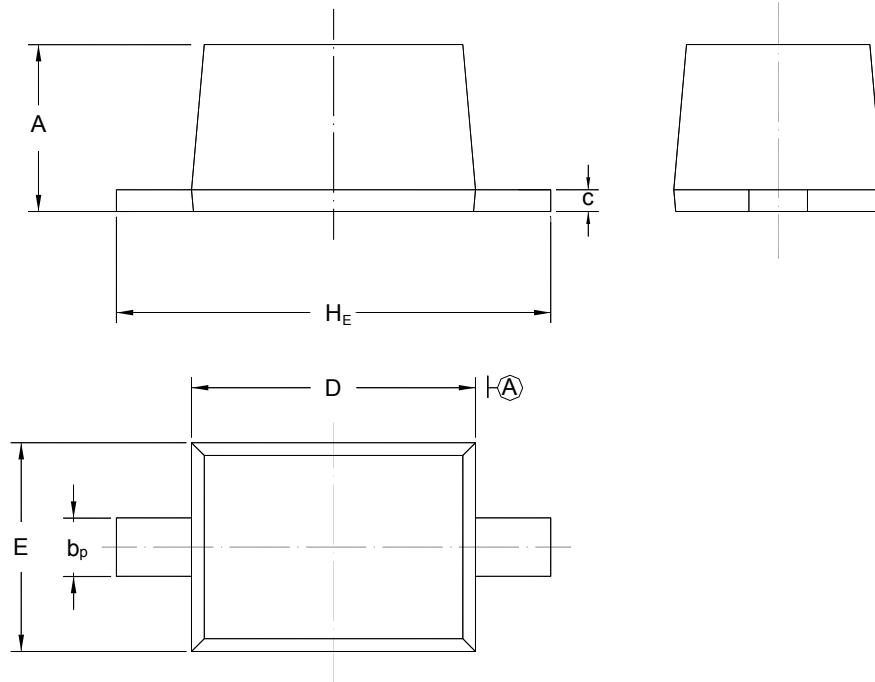

UNIT	A	b _p	C	D	E	H _E
mm	1.10 0.80	0.40 0.25	0.15 0.10	1.80 1.60	1.35 1.15	2.80 2.30