

# 1N4148W

## Silicon Epitaxial Planar Switching Diode

### Features

- SOD-123 package
- Fast switching
- These diodes are also available in other case style including the DO-35 case with the type designation 1N4148, the MiniMELF case with the type designation LL4148 and the MicroMELF case with the type designation MCL4148.

### PINNING

PIN	DESCRIPTION
1	Cathode
2	Anode

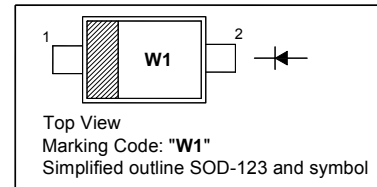

### Absolute Maximum Ratings ( $T_a = 25\text{ }^\circ\text{C}$ )

Parameter	Symbol	Value	Unit
Peak Reverse Voltage	$V_{RM}$	100	V
Reverse Voltage	$V_R$	75	V
Average Rectified Forward Current	$I_{F(AV)}$	150	mA
Non-repetitive Peak Forward Surge Current at $t = 1\text{ }\mu\text{s}$	$I_{FSM}$	2	A
Power Dissipation	$P_{tot}$	400	mW
Thermal Resistance from Junction to Ambient Air	$R_{\theta JA}$	312	$^\circ\text{C/W}$
Junction Temperature	$T_j$	150	$^\circ\text{C}$
Storage Temperature Range	$T_{stg}$	- 65 to + 150	$^\circ\text{C}$

### Electrical Characteristics ( $T_a = 25\text{ }^\circ\text{C}$ )

Parameter	Symbol	Max.	Unit
Forward Voltage at $I_F = 10\text{ mA}$	$V_F$	1	V
Reverse Current at $V_R = 20\text{ V}$ at $V_R = 75\text{ V}$ at $V_R = 20\text{ V}, T_J = 150\text{ }^\circ\text{C}$	$I_R$	25 5 50	nA $\mu\text{A}$ $\mu\text{A}$
Total Capacitance at $V_R = 0\text{ V}, f = 1\text{ MHz}$	$C_{tot}$	4	pF
Reverse Recovery Time at $I_F = 10\text{ mA}$ to $I_R = 1\text{ mA}, V_R = 6\text{ V}, R_L = 100\text{ }\Omega$	$t_{rr}$	4	ns

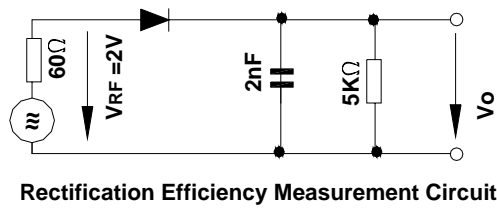

Rectification Efficiency Measurement Circuit

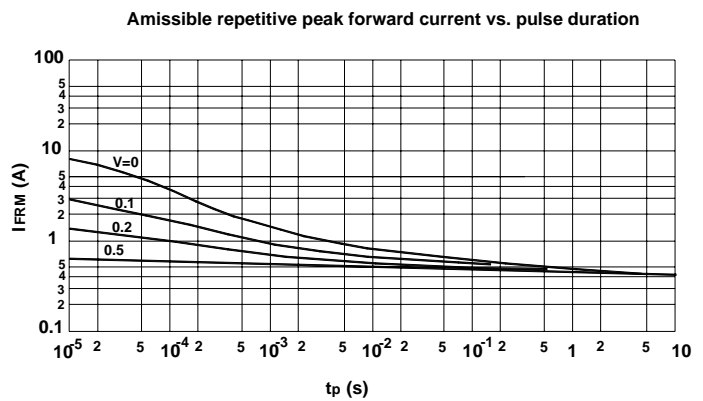
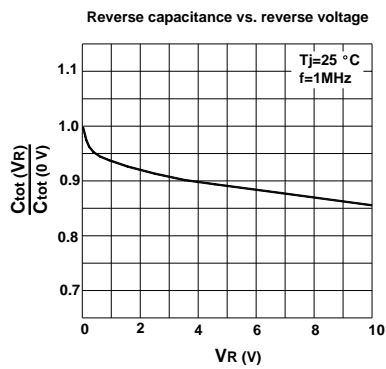
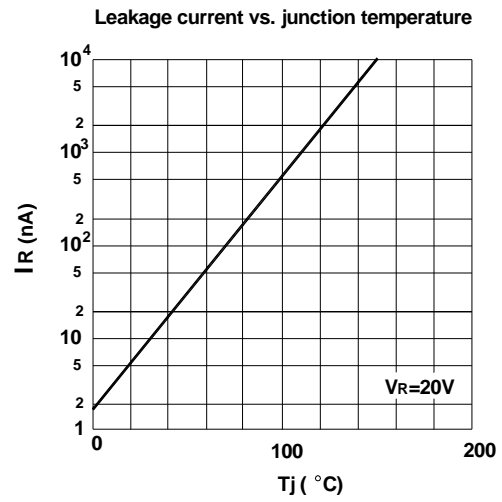
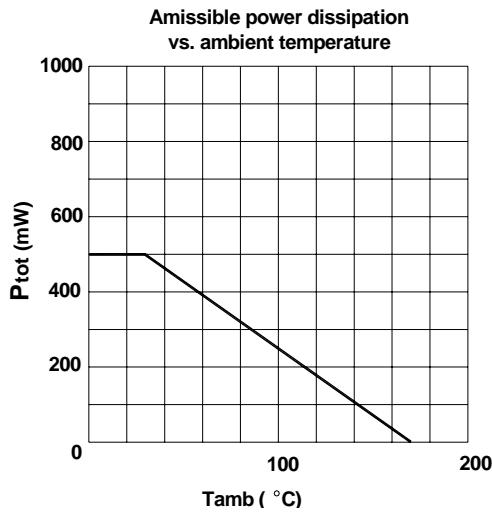
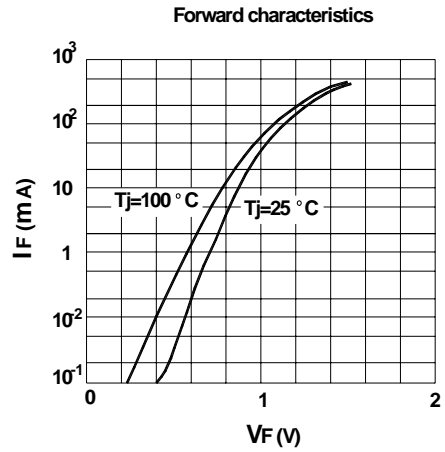

# 1N4148W

## PACKAGE OUTLINE

Plastic surface mounted package; 2 leads

SOD-123

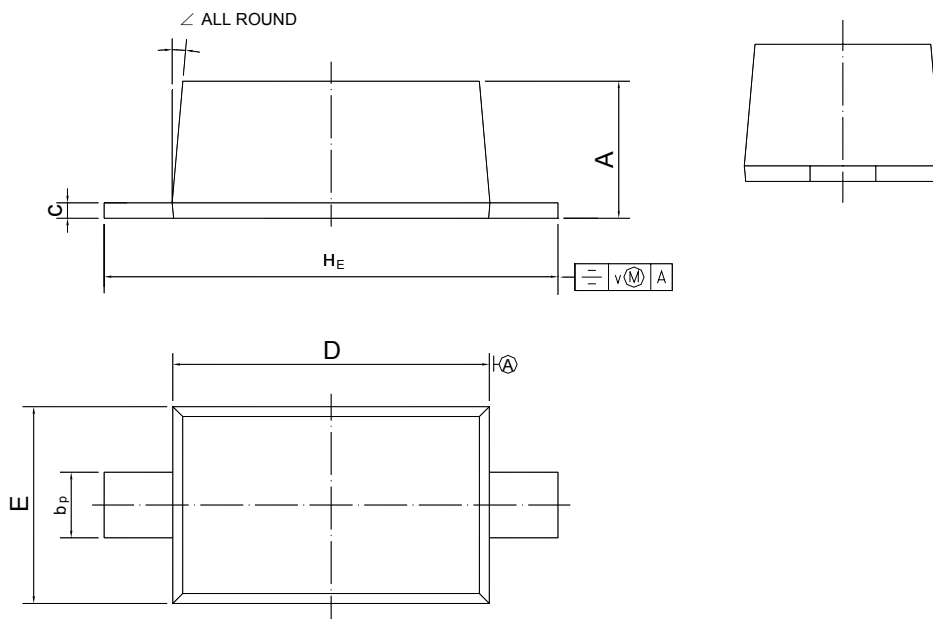

UNIT	A	b <sub>p</sub>	c	D	E	H <sub>E</sub>	v	∠
mm	1.15 1.05	0.6 0.5	0.135 0.100	2.7 2.6	1.65 1.55	3.85 3.55	0.2	5°